

This Application note provides an example of how to test a medical device per IEC/UL 60601-1 3rd Edition using the Associated Research MedTEST System.

Table 1 lists all the instruments shown in the test setup used as an example in this document.

Instrument Name/Model	Capabilities and Functions
OMNIA II model 8207 Electrical Safety Compliance Analyzer	Ground Bond/Continuity, AC/DC Withstand, Insulation Resistance, Leakage Current, Functional Run and built-in 500 VA AC Source
SC6540 Scanning Matrix Main 16 Channel HV	16 high voltage channels for multi-point testing
SC6540 Scanning Matrix Secondary 8 Channel HV	8 high voltage channel for additional test points
Associated Power Technologies model APT320XAC	Programmable AC output 2 kVA
Class 1 Medical Device with 2 Applied Parts labeled as DUT – Device Under Test	Can be any medical device with applied parts. Applied part is a part of Medical Electrical Equipment that in normal use necessarily comes into physical contact with the patient to perform its function.

Table 1

Impedance and Current Carrying Capability (Ground Bond Test)

IEC/UL 60601-1 Clause 8.6.4 Impedance and Current Carrying Capability

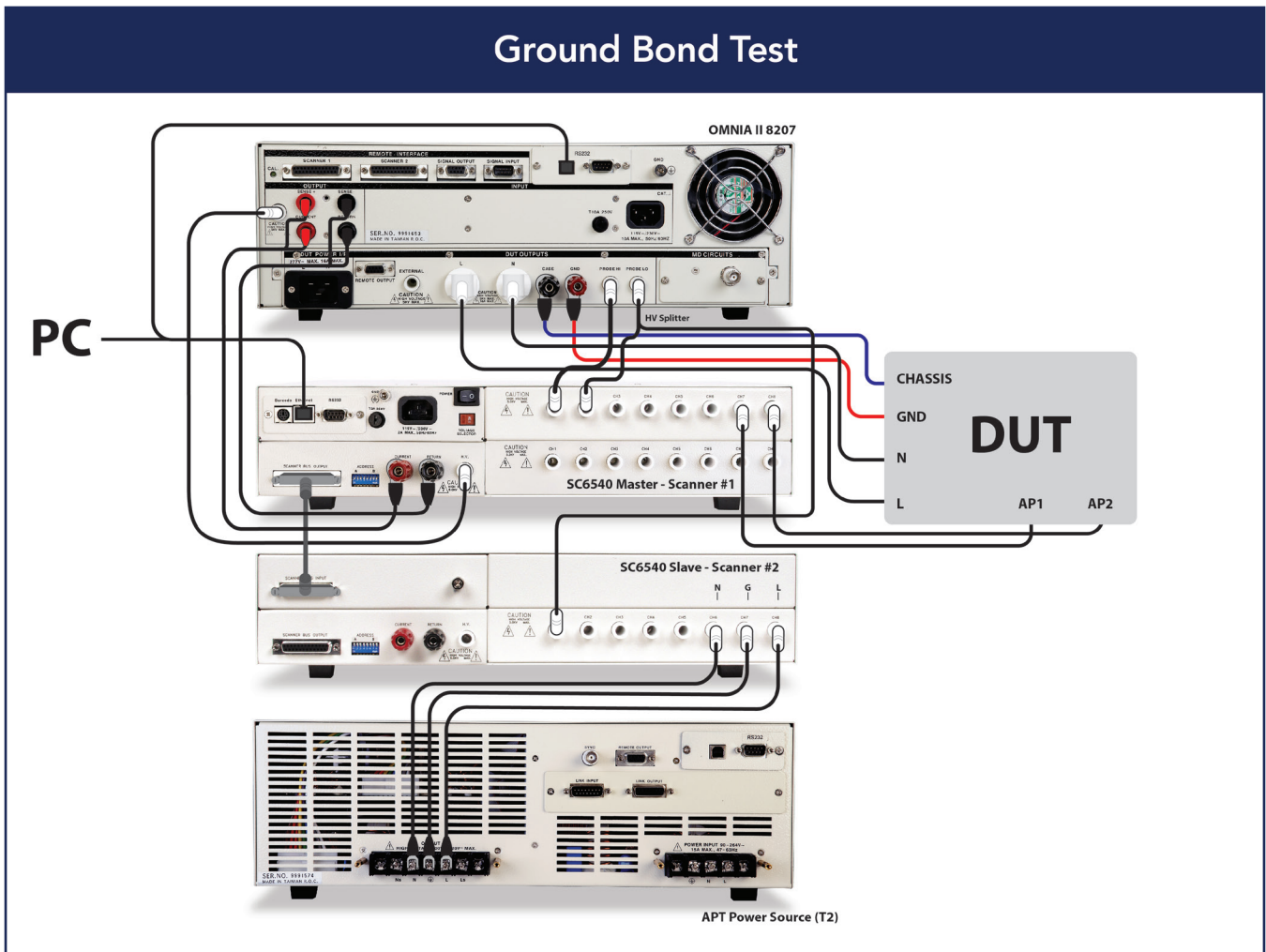

Figure 1 - Ground Bond Test Connections

Active connections are shown in red in Figure 1.

Test Type	Points Under Test	Active Connections	Scanner Channels
Ground Bond	DUT GND – DUT Chassis	GND and CASE	None

Table 2

Dielectric Strength (The Hipot Test)

IEC60601-1 Clause 8.8.3 Dielectric Strength

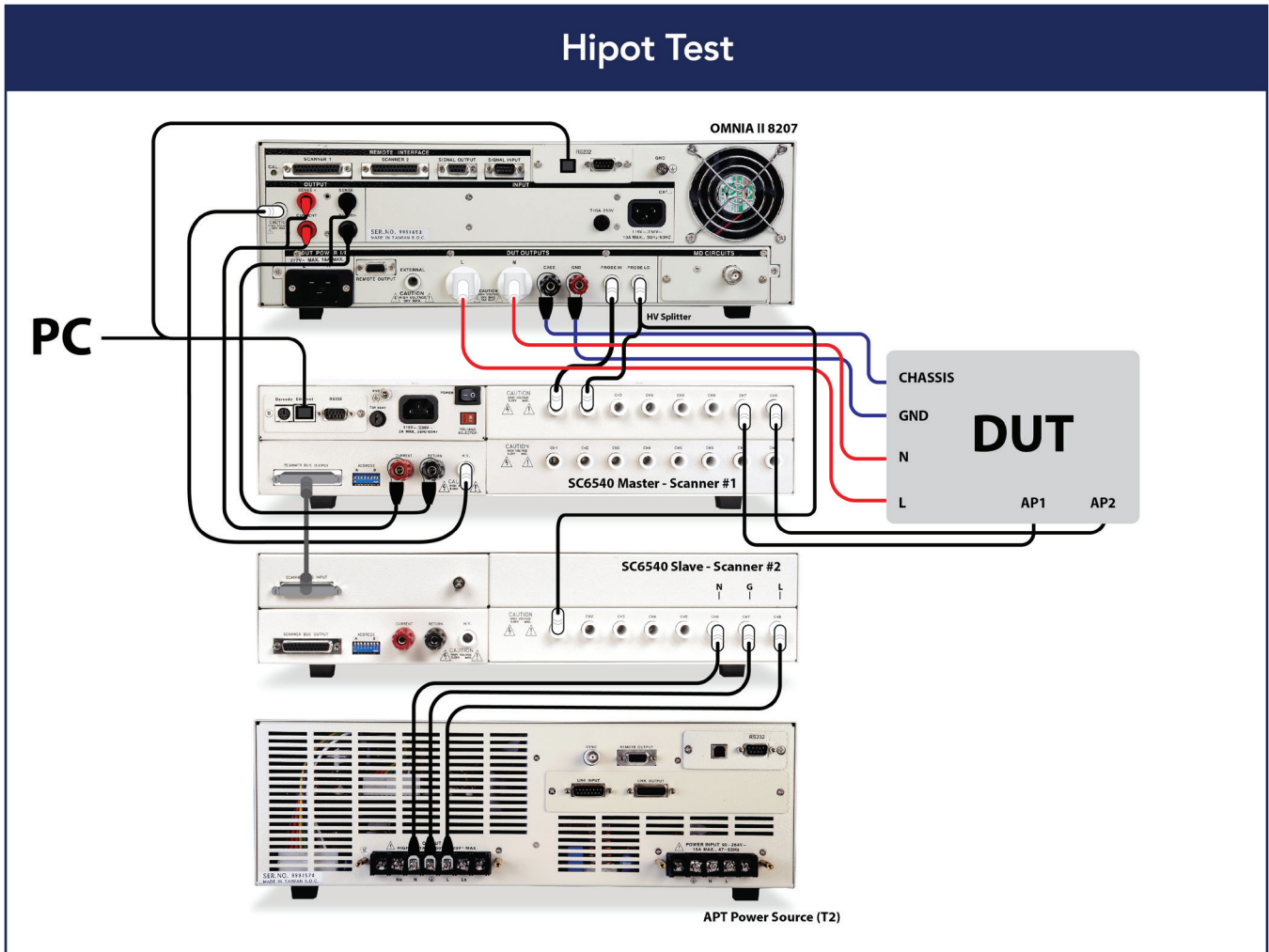

Figure 2 - Hipot Test Connections

Active connections are shown in red Figure 2.

Test Type	Points Under Test	Active Connections	Scanner Channels
Hipot	DUT Mains to Chassis	L, N and Case	None

Table 3

Dielectric Strength (Applied Part Hipot Test)

IEC/UL 60601-1 Annex L - Section L. 4

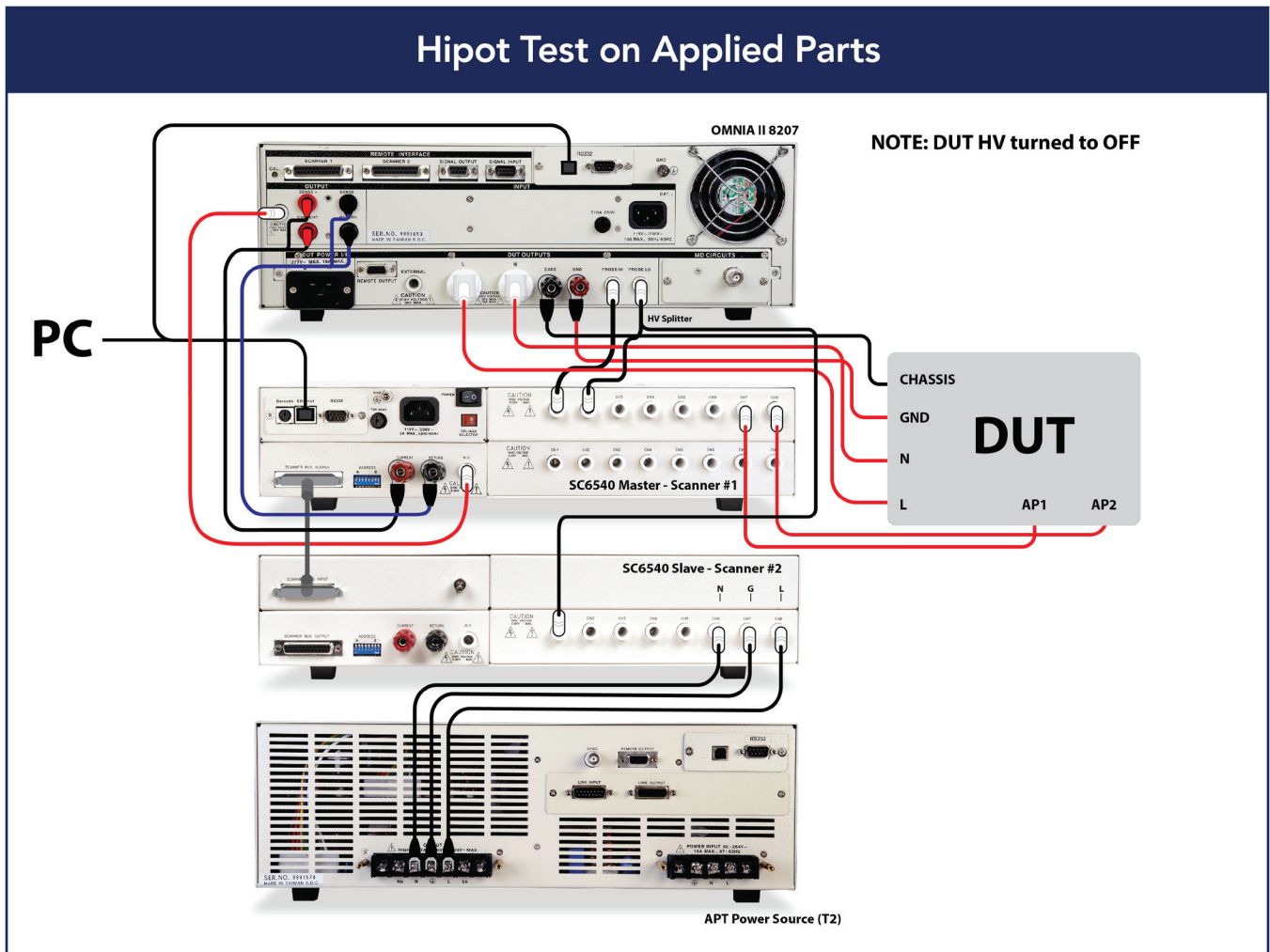

Figure 3

Test Type	Points Under Test	Active Connections	Scanner Channels
Applied Part Hipot	DUT Mains to Applied Part (AP1 or AP2)	L, N and Return *Disconnect GND lug of the 38578 box from Omnia and the Case connection	Scanner 1: CH15 or CH16 set to Lo
	Applied Part to DUT Mains	AP1 or AP2 and DUT L, N or GND *Disconnect GND lug of the 38578 box from Omnia and the Case connection	---

Table 4

Leakage Current and Patient Auxiliary Current

IEC/UL 60601-1 Clause 8.7 Leakage Current and Patient Auxiliary Current* (The Leakage Current Test)

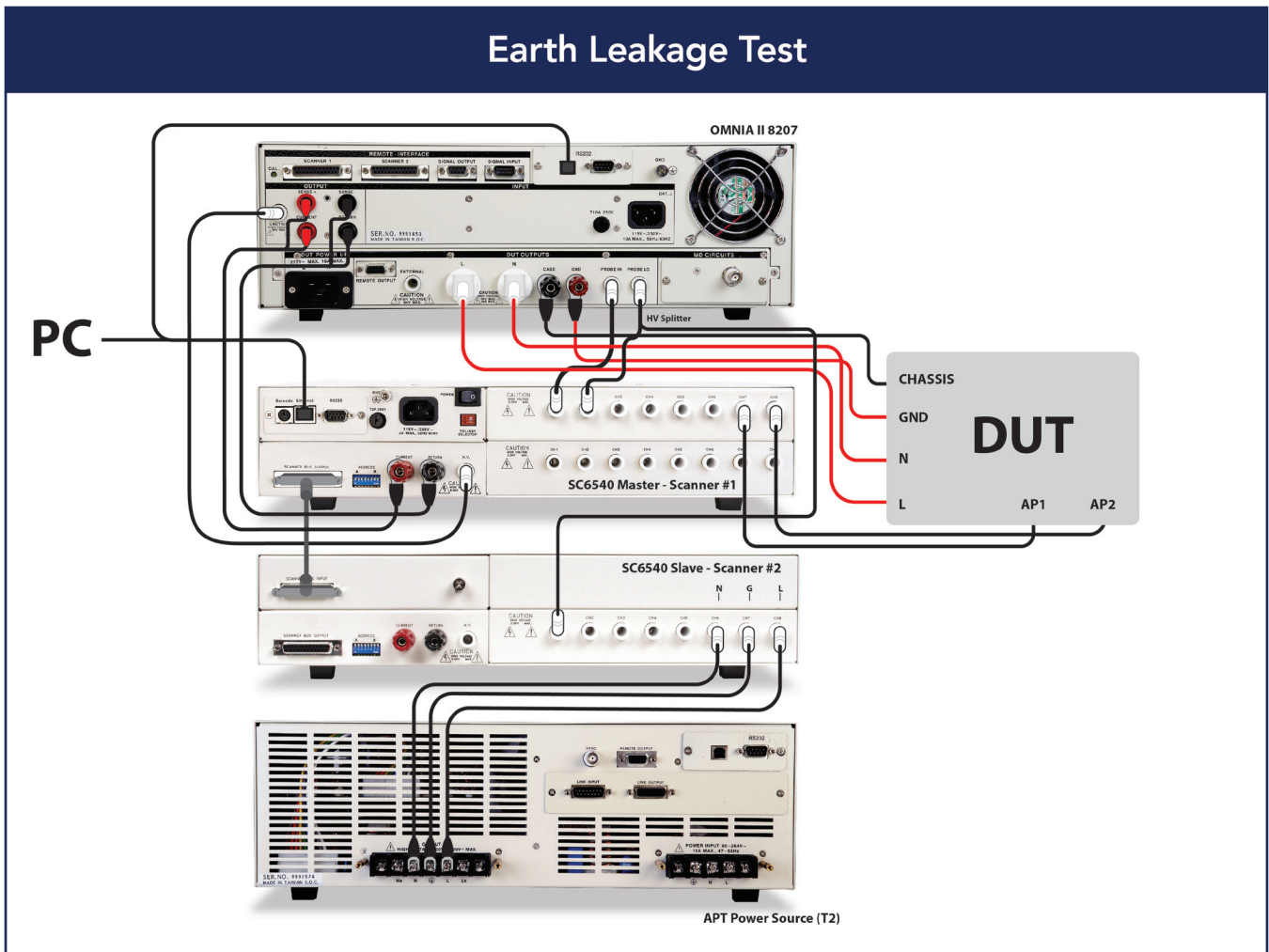

Figure 4

Test Type	Points Under Test	Active Connections	Scanner Channels
LCT - Earth Leakage	N and GND	L, N and GND	None

Table 5

Enclosure Leakage Test

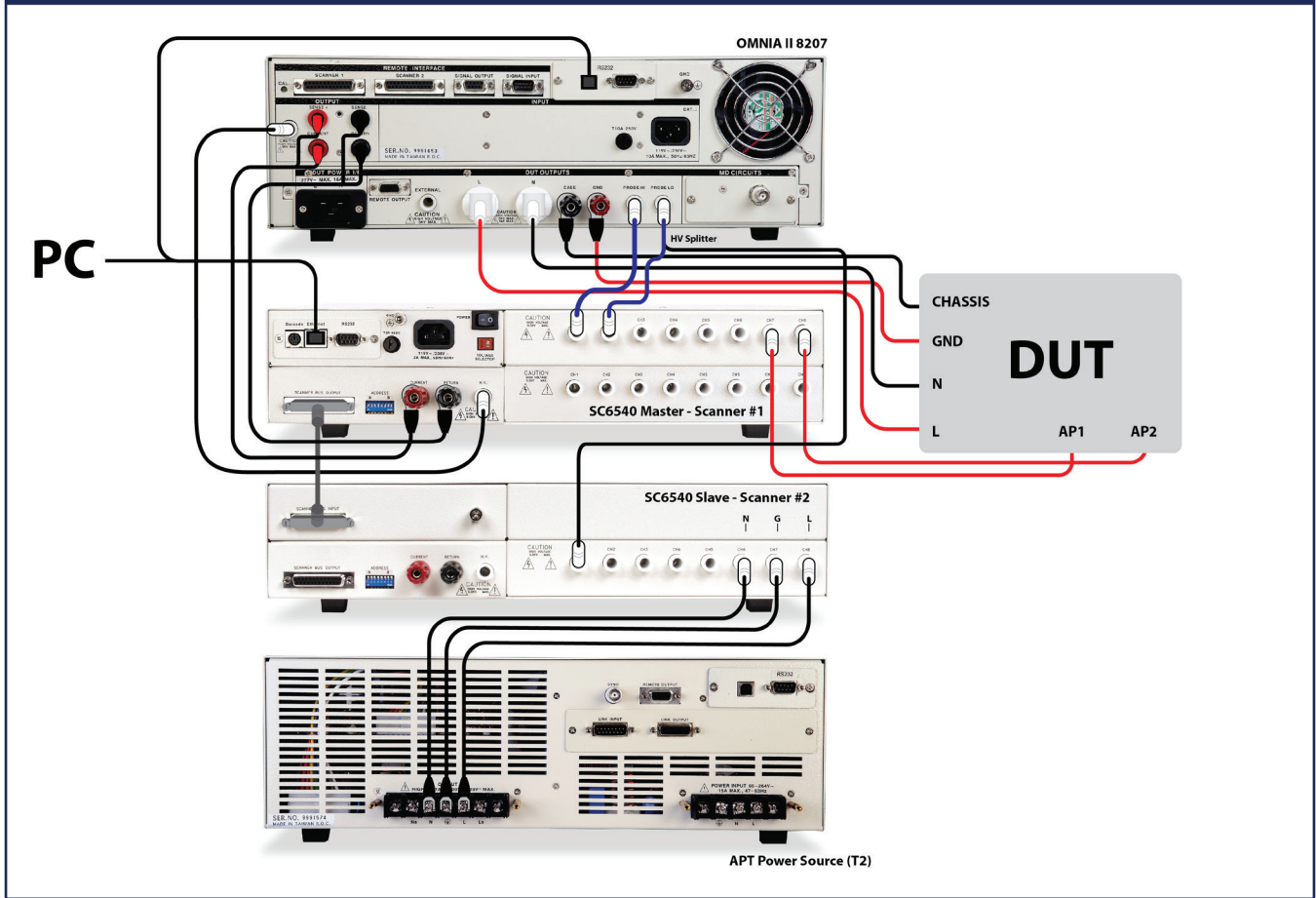

Figure 5

Test Type	Points Under Test	Active Connections	Scanner Channels
LCT - Enclosure Leakage	Enclosure points (EP1 or EP2)	L, N and Probe Hi *LCT - Enclosure Leakage	Scanner 1: CH 9 Hi and CH15/CH16 Hi depending on point under test.

Table 6

Applied Part Leakage

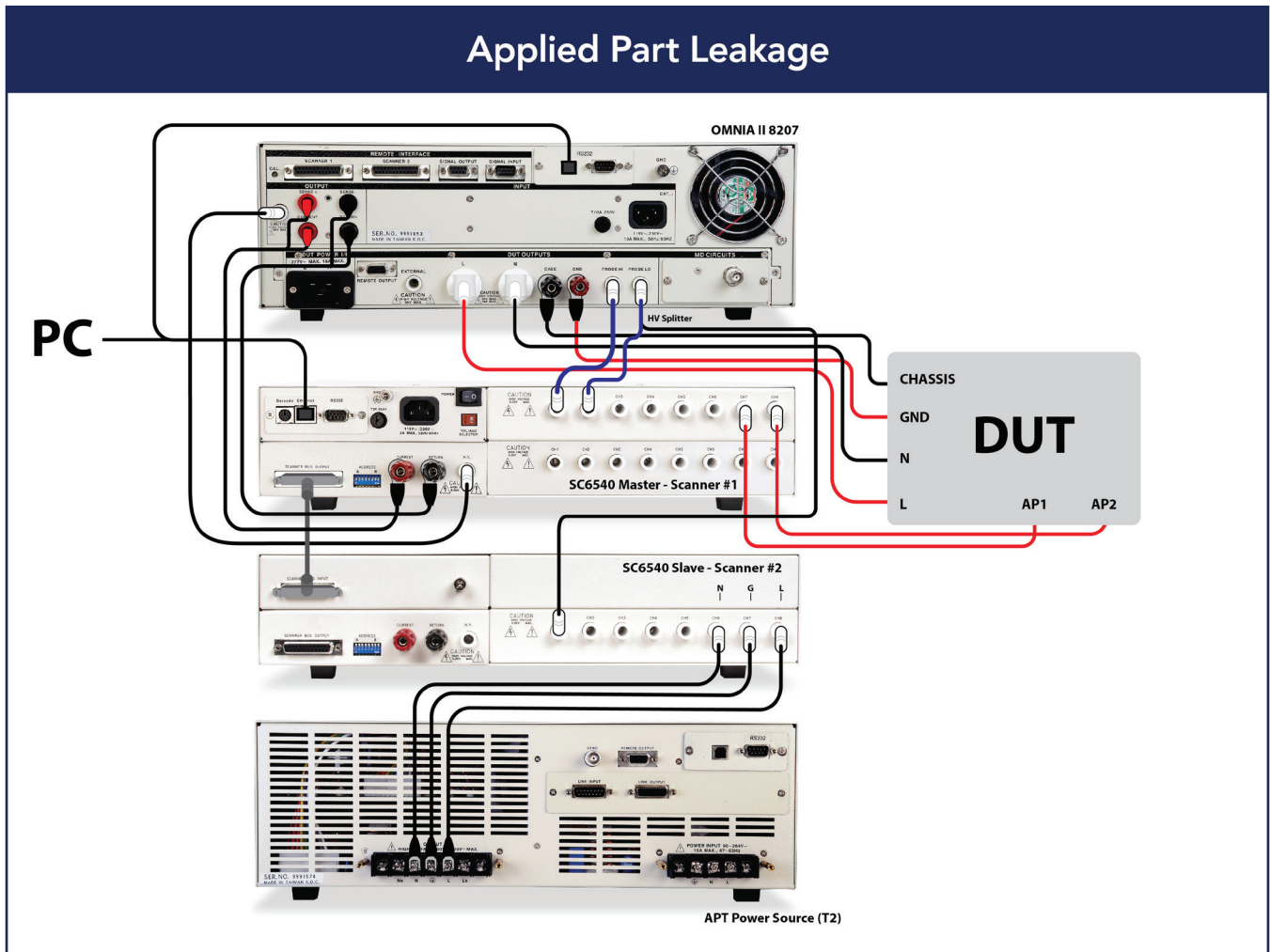

Figure 6

Test Type	Points Under Test	Active Connections	Scanner Channels
LCT - Applied Part Leakage	Applied Parts AP1 and/or AP2 *There can be more than two applied parts	L, N and Probe Hi and Probe Lo *Probe Configuration – Probe Hi to Line for single Applied part and Probe Hi to Probe Lo for testing between two Applied Parts	Scanner 1: Single applied part – CH9 Hi and CH15/16 Hi Two Applied parts – (CH9 and CH15) Hi (CH10 and CH16) Lo

Table 7

Mains on Applied Part Leakage

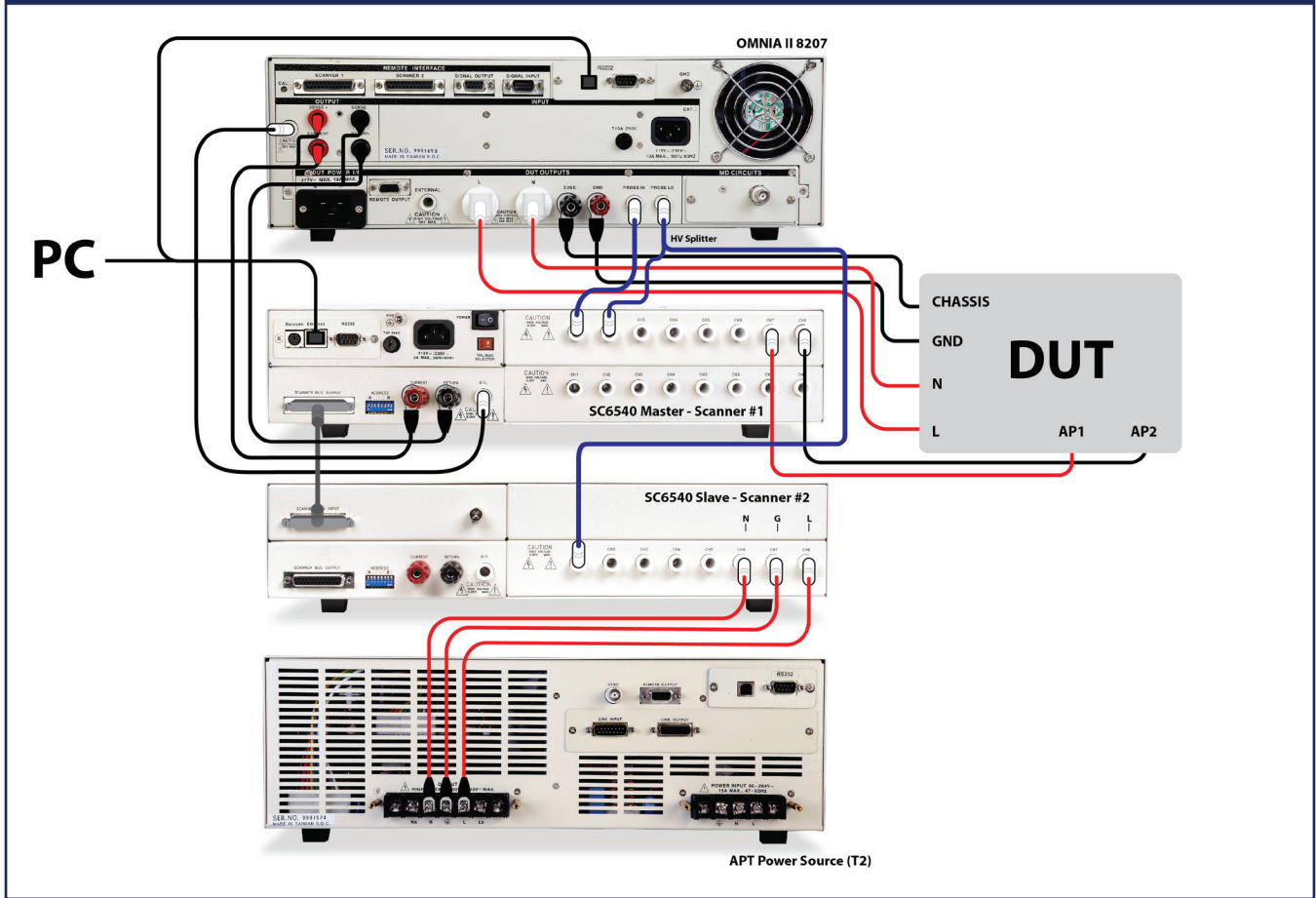

Figure 6

Test Type	Points Under Test	Active Connections	Scanner Channels
LCT – Mains Applied Part Leakage	L, N, Probe Hi and Probe Lo	L, N and Probe Hi and Probe Lo *Probe Configuration – Probe Hi to Probe Lo	Scanner 1: (CH7 and CH1) Hi Scanner 2: (CH1 and CH8) HI, (CH6 and CH7) Lo

Table 7